



Specifications

Nominal Voltage		12 V
Capacity (25°C)	20HR(10.5V)	4.5Ah
	10HR(10.5V)	4.2Ah
	1HR(9.60V)	2.93Ah
Dimension	Length	90 ± 1mm (3.54inch)
	Width	70 ± 1mm (2.76inch)
	Height	101 ± 1mm (3.98inch)
	Total Height	107 ± 1mm (4.21inch)
Approx. Weight		1.46kg (3.22lbs) ± 5%
Terminal type		T1/T2
Internal resistance (Fully charged, 25°C)		Approx. 45mΩ
Capacity affected by temperature (20HR)	40°C	102%
	25°C	100%
	0°C	85%
	-15°C	65%
Self-discharge (25°C)	3 month	Remaining Capacity: 91%
	6 month	Remaining Capacity: 82%
	12 month	Remaining Capacity: 65%
Nominal operating temperature		25°C ± 3°C (77°F ± 5°F)
Operating temperature range	Discharge	-15°C ~ 50°C (5°F ~ 122°F)
	Charge	-10°C ~ 50°C (14°F ~ 122°F)
	Storage	-20°C ~ 50°C (-4°F ~ 122°F)
Float charging voltage(25°C)		13.60 to 13.80V Temperature compensation: -18mV/°C
Cyclic charging voltage(25°C)		14.50 to 14.90V Temperature compensation: -30mV/°C
Maximum charging current		1.35A
Terminal material		Copper
Maximum discharge current		67.5A(5 sec.)
Designed floating life(20°C)		10years



Dimensions

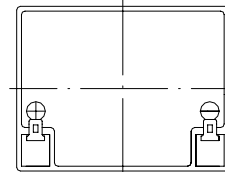
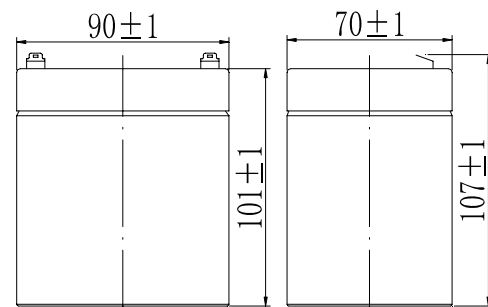

Terminal

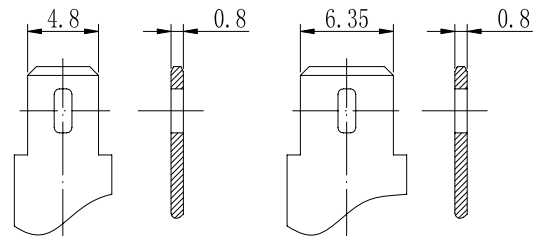

Terminal T1

Terminal T2

- ◆ Absorbent glass mat technology;
- ◆ Recognized by UL & CE;
- ◆ ABS container.

Constant Current Discharge Characteristics (A, 25°C)

F.V/TIME	5min	10min	15min	30min	60min	2h	3h	4h	5h	10h	20h
9.60V	17.1	10.8	8.55	4.77	2.93	1.60	1.15	0.92	0.78	0.42	0.228
9.90V	16.6	10.5	8.34	4.67	2.88	1.59	1.14	0.91	0.78	0.42	0.227
10.2V	15.9	10.0	8.04	4.53	2.81	1.58	1.13	0.91	0.77	0.42	0.226
10.5V	15.2	9.61	7.76	4.42	2.75	1.55	1.13	0.90	0.77	0.42	0.225
10.8V	14.4	9.07	7.35	4.26	2.67	1.51	1.09	0.87	0.74	0.41	0.221

Constant Power Discharge Characteristics (Watt, 25°C)

F.V/TIME	5min	10min	15min	30min	60min	2h	3h	4h	5h	10h	20h
9.60V	191	122	97.5	54.7	33.9	18.7	13.6	10.9	9.32	5.10	2.74
9.90V	185	118	95.1	53.6	33.4	18.6	13.6	10.9	9.26	5.08	2.73
10.2V	177	113	91.6	51.9	32.5	18.4	13.5	10.8	9.20	5.05	2.72
10.5V	170	108	88.5	50.7	31.9	18.2	13.4	10.7	9.13	5.02	2.70
10.8V	160	102	83.8	48.8	30.9	17.7	13.0	10.4	8.86	4.92	2.65

Note: The above characteristics data can be obtained within three charge/discharge cycles.



Discharge Characteristics(25°C)

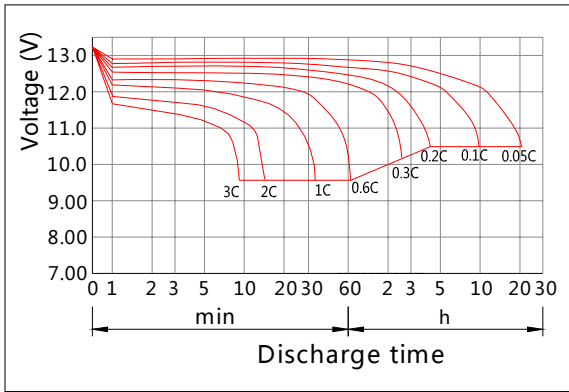

Charging Characteristics(25°C)

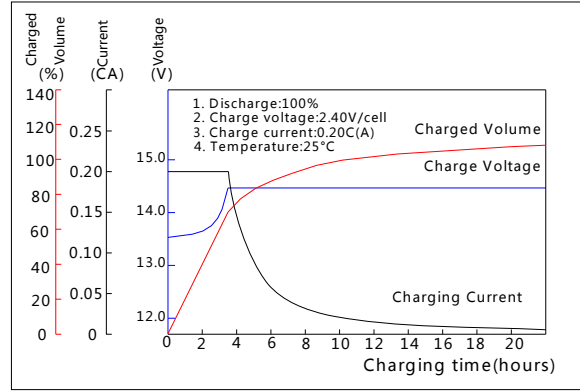

Effect of Temperature on Capacity

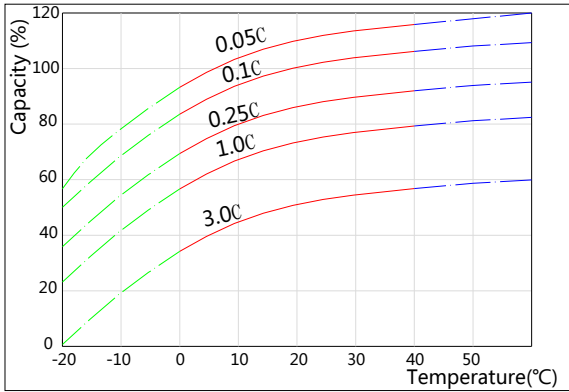

Self-discharge Characteristics

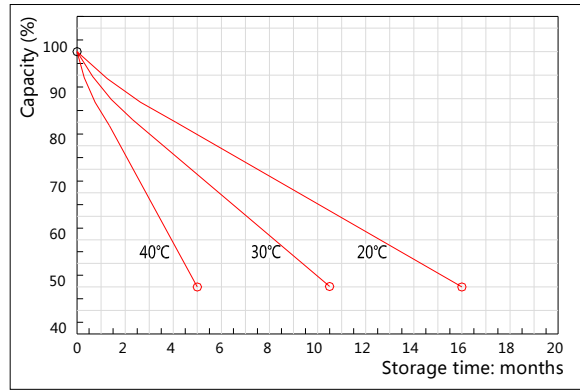

The Relationship for Open Circuit Voltage and Residual Capacity (25°C)

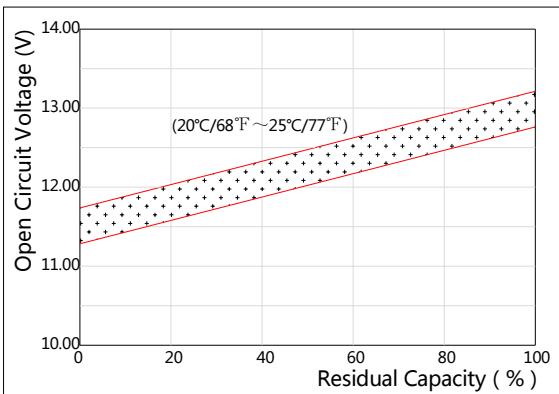

The Relationship for Charging Voltage and Temperature

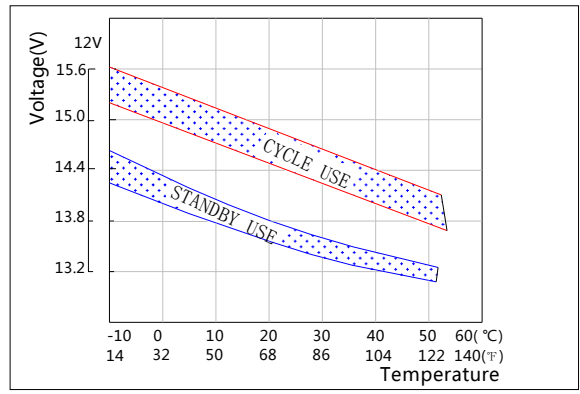

Floating Life on Temperature

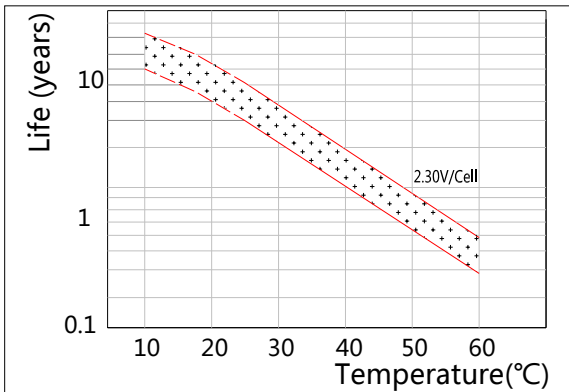

Cycle Life on D.O.D(25°C)

